

AI-1001W V2

Quick Installation Guide

07-2018 / v1.2

Edimax Technology Co., Ltd.

No. 278, Xinhua 1st Rd., Neihu Dist., Taipei City, Taiwan

Email: support@edimax.com.tw

Edimax Technology Europe B.V.

Fijenhof 2, 5652 AE Eindhoven, The Netherlands

Email: support@edimax.nl

Edimax Computer Company

3350 Scott Blvd., Bldg.15 Santa Clara, CA 95054, USA

Live Tech Support: 1(800) 652-6776

Email: support@edimax.com

Installation Reminder / Safety Guide

For effective sensing and retrieval of environmental data, please install the unit in semi-outdoor spaces with certain safety restrictions outlined below:

- Must be in locations with good air circulation.
- Must be vertically positioned for proper air intake to achieve cross ventilation.
- The air inlet must be kept clear and should be rechecked regularly.
- Must be in locations close to a power supply and have good Wi-Fi internet signal capable of connecting to the Internet.
- Must be in well ventilated semi-outdoor spaces such as eaves of a house, verandah, balcony, porch, covered patios, etc...
- Must not be installed in locations that are subject to extremes of humidity or temperature such as near fire or other heat sources.
- Must not be installed in locations that are subject to extreme weather conditions such as typhoon, heavy rain or dust storm; or it must be sheltered from the conditions.
- Must not be installed in locations directly exposed to sunlight or reflected light source.
- Must not be installed in corrosive environments such as in environments with salty, acidic or basic air, or places with storage of corrosive liquids.
- Must be placed at least 100cm above ground.
- Do not inject gas, contaminants, or smoke directly into the unit.
- It is recommended to keep a 150m distance between each unit to achieve map positioning and air quality data accuracy.

If you wish to monitor a specific location, please also follow the restrictions above.

If you have any questions, please contact our technical support via email: service@edimax.com.tw.

Device Cleaning

Choose either **A** or **B** depending on the cleaning tool you have.

NOTE: If you have other pump-like cleaning tools available (e.g. for computers), you may also utilize them. Please be careful to not exert extremes of force or temperature / humidity onto the sensors to prevent damaging them.

A. Air Pump Cleaner

1. Direct the nozzle of the air pump cleaner at an opening (**Figure 1** or **Figure 2**) of a sensor.
2. Squeeze the bulb to blow air at the sensors.
3. Do this for 5-10 times and make sure all sensor openings are cleaned.

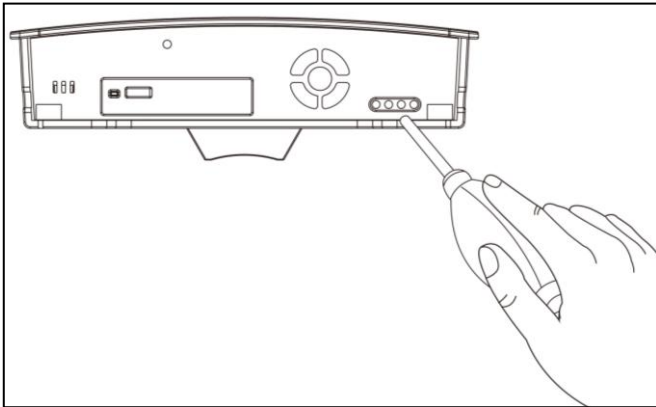

Figure 1

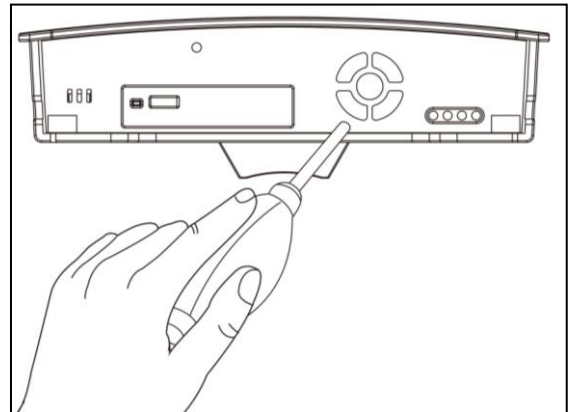

Figure 2

B. Dust-off Canned Compressed Air

1. Direct the nozzle of the compressed air at an opening (**Figure 3** or **Figure 4**) of a sensor.
2. Keep the nozzle at 10cm from the sensor opening.
3. Use **short bursts** (1-2 seconds) of air spray **a few times** to clean the sensor.
4. Make sure all sensor openings are cleaned.

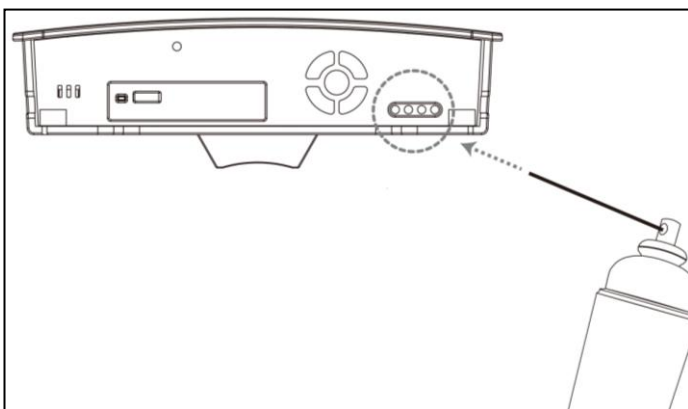

Figure 3

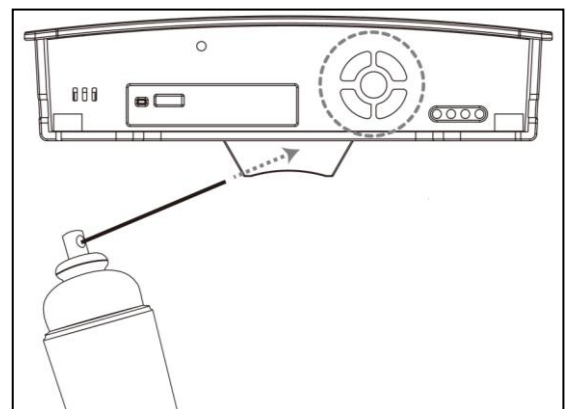
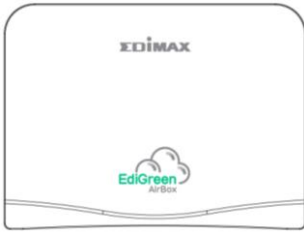

Figure 4

It is recommended to clean the sensors every 3-6 months for maximum sensor functionality.

Package Contents



AI-1001W



CD



QIG

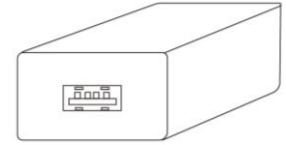

Power Adapter

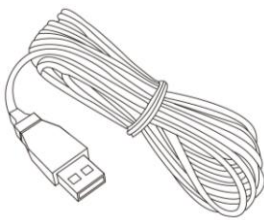

USB Cable

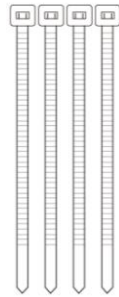



Cable ties



Screws

LED Status

LED	Color	Status	Description
Power 	Red	Flashing	AirBox is waiting for setup.
		Off	AirBox is finish configuration.
Wi-Fi 	Green	On	Wi-Fi is connected.
		Flashing	Wi-F is active but not connected.
Internet 	Green	On	Internet is connected.
		Flashing	Internet is not connected.

Setup & App

1. Use your Smartphone or tablet to search, download and install the **EdiGreen** app from Google Play or the Apple App Store.



2. The best location for your AirBox is **outdoors with shelter/cover** from rain. The unit is **water-resistant** but not water-proof. Screw and cable tie sets are also included to help mount the device to a wall if you wish.
3. Connect the USB power adapter to the AirBox using the USB cable, and plug in the power adapter. The **red** power LED will **flash**.

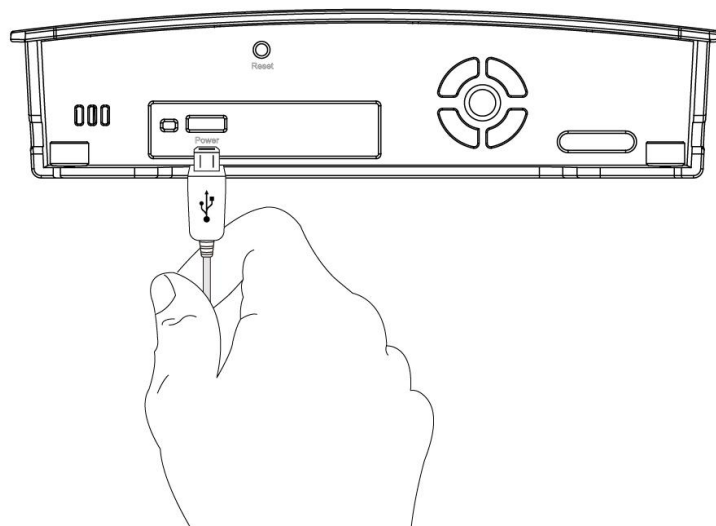

- 4.** Ensure that your Smartphone is connected to your existing Wi-Fi and that **GPS/location tracking is enabled.**

iOS

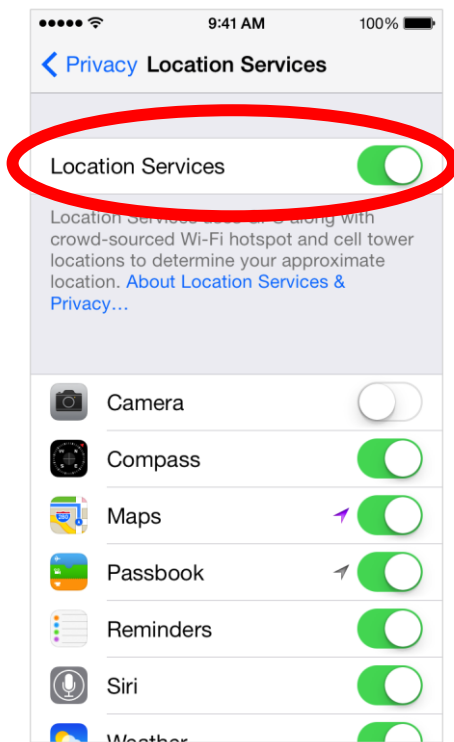

Android

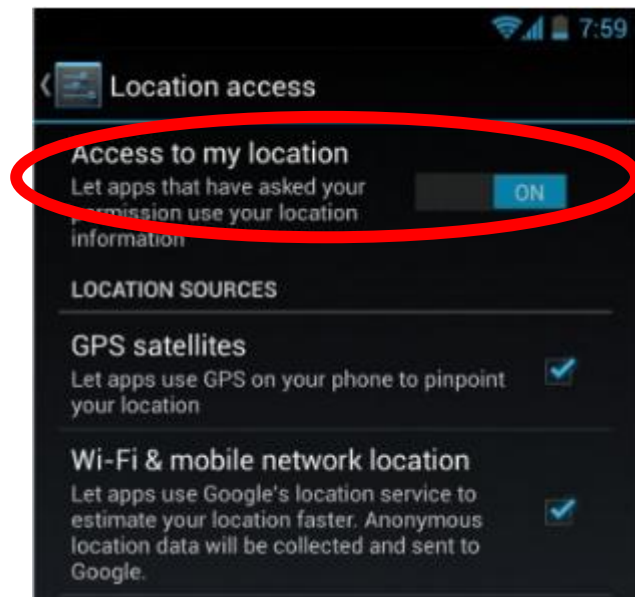

- 5.** For **iOS users**, go to your iPhone's Wi-Fi settings and connect to your AirBox's SSID (PM2.5_Setup **), before opening the EdiGreen app. The last two characters are unique to your device. Continue to **Step 8.**

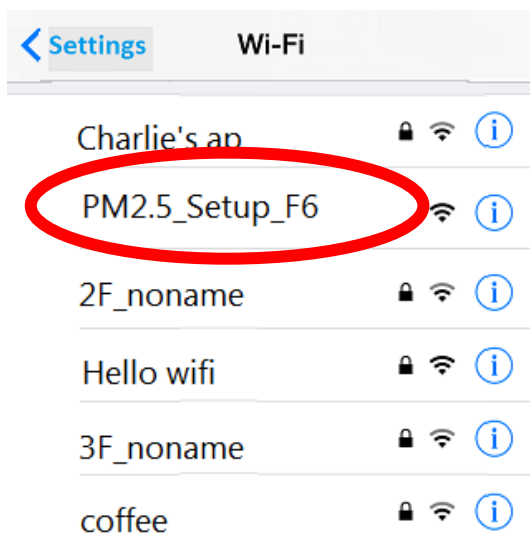

6. Android users open the EdiGreen app and tap the icon in the top right corner of the screen.

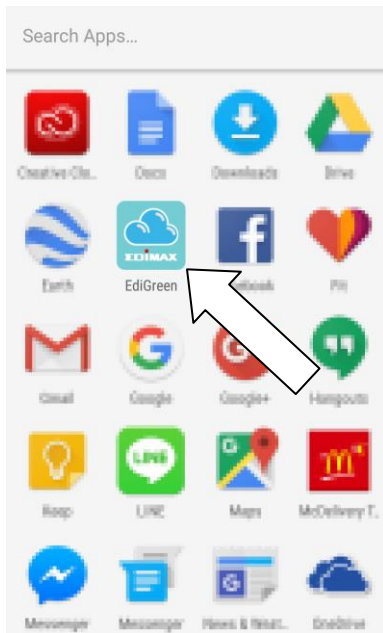

7. Select **Add New Device** and select your AirBox (PM2.5_Setup**), from the **Available wireless device list**. The last two characters are unique to your device.

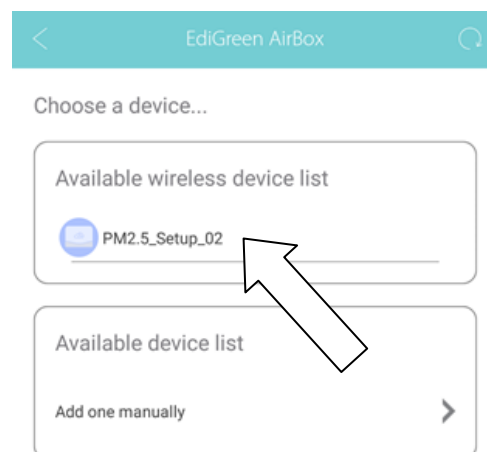
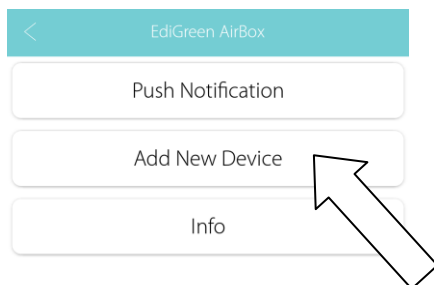

- 8.** For better security, enter a new device name and password when prompted. After setup, you can use this new name and password to login, including from a second device. Tap the > icon to continue.

Due to Security, please change default configuration below

Please enter a device name

New password

Confirm password

Show password

EdiGreen AirBox













Due to Security, please change default configuration below

Please enter a device name

- 9.** Select your Wi-Fi network from the list and then enter your Wi-Fi password, before clicking the > icon to complete setup.

Select Wi-Fi

max866799		
JackWAP		
Jackchen		
DIRECT-V8-BRAVIA		
matt		

EdiGreen AirBox

SSID:matt

Please enter your Wi-Fi password

Show password

10. Setup is complete. Your AirBox will be listed in the **All** and **Favorite Lists** and **Maps**. You can tap on any AirBox for more detailed data, and create a list of favorites. Explore the app!

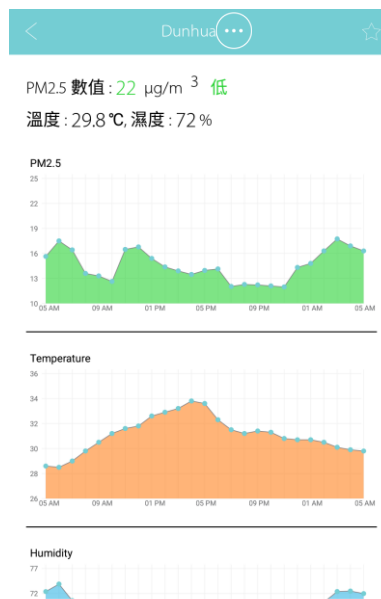

You can also connect to your AirBox on a second Wi-Fi device. Just download the app and add it in the same way. If you're connected to a different Wi-Fi network, then select "Add one manually" and input the MAC address printed on the AirBox label.

FAQs

How do I add my AirBox to another mobile device?

After setup, you can add your AirBox to the EdiGreen app on another mobile device, from any network. Tap the **main menu** icon in the top right and select **Add New Device**. Then:

- If your mobile device is on the same Wi-Fi as your AirBox, your AirBox will display in the **Available Device List**. Select it and enter the username and password.
- From any other network, select **Add One Manually** and enter the MAC Address, username and password.

How do I change the name or location of my AirBox?

Go into your AirBox in the EdiGreen app and tap the **settings** icon in the top right. From here you select **Change Name** or **Change Location**. When you change the location, **tap and hold** the map pin and **drag** it to the new location.



Reset

If you experience problems with your AirBox, you can reset the AirBox back to its factory default settings. This resets **all** settings back to default.

Use a pencil or other object with a fine tip to press and hold the Reset button on the back panel for at least 10 seconds. Release the button when the **red** power LED is **flashing**, and wait a couple of minutes for the unit to restart.

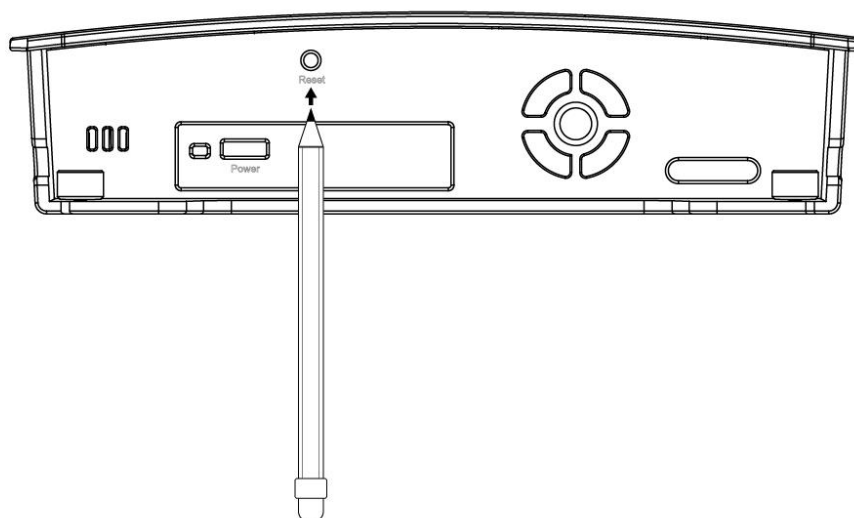

COPYRIGHT

Copyright © Edimax Technology Co., Ltd. all rights reserved. No part of this publication may be reproduced, transmitted, transcribed, stored in a retrieval system, or translated into any language or computer language, in any form or by any means, electronic, mechanical, magnetic, optical, chemical, manual or otherwise, without the prior written permission from Edimax Technology Co., Ltd.

Edimax Technology Co., Ltd. makes no representations or warranties, either expressed or implied, with respect to the contents hereof and specifically disclaims any warranties, merchantability, or fitness for any particular purpose. Any software described in this manual is sold or licensed as is. Should the programs prove defective following their purchase, the buyer (and not this company, its distributor, or its dealer) assumes the entire cost of all necessary servicing, repair, and any incidental or consequential damages resulting from any defect in the software. Edimax Technology Co., Ltd. reserves the right to revise this publication and to make changes from time to time in the contents hereof without the obligation to notify any person of such revision or changes.

The product you have purchased and the setup screen may appear slightly different from those shown in this QIG. The software and specifications are subject to change without notice. Please visit our website www.edimax.com for updates. All brand and product names mentioned in this manual are trademarks and/or registered trademarks of their respective holders.

Federal Communication Commission Interference Statement

15.21

You are cautioned that changes or modifications not expressly approved by the part responsible for compliance could void the user's authority to operate the equipment.

15.105(b)

This equipment has been tested and found to comply with the limits for a Class B digital device, pursuant to part 15 of the FCC rules. These limits are designed to provide reasonable protection against harmful interference in a residential installation. This equipment generates, uses and can radiate radio frequency energy and, if not installed and used in accordance with the instructions, may cause harmful interference to radio communications. However, there is no guarantee that interference will not occur in a particular installation. If this equipment does cause harmful interference to radio or television reception, which can be determined by turning the equipment off and on, the user is encouraged to try to correct the interference by one or more of the following measures:

- Reorient or relocate the receiving antenna.
- Increase the separation between the equipment and receiver.
- Connect the equipment into an outlet on a circuit different from that to which the receiver is connected.
- Consult the dealer or an experienced radio/TV technician for help.

This device complies with Part 15 of the FCC Rules. Operation is subject to the following two conditions:

- 1) this device may not cause harmful interference and
- 2) this device must accept any interference received, including interference that may cause undesired operation of the device.

FCC RF Radiation Exposure Statement:

This Transmitter must not be co-located or operating in conjunction with any other antenna or transmitter.

This equipment complies with FCC RF radiation exposure limits set forth for an uncontrolled environment. This equipment should be installed and operated with a minimum distance of 20 centimeters between the radiator and your body.

R&TTE Compliance Statement

This equipment complies with all the requirements of DIRECTIVE 1999/5/EC OF THE EUROPEAN PARLIAMENT AND THE COUNCIL of March 9, 1999 on radio equipment and telecommunication terminal equipment and the mutual recognition of their conformity (R&TTE). The R&TTE Directive repeals and replaces in the directive 98/13/EEC (Telecommunications Terminal Equipment and Satellite Earth Station Equipment) As of April 8, 2000.

Safety

This equipment is designed with the utmost care for the safety of those who install and use it. However, special attention must be paid to the dangers of electric shock and static electricity when working with electrical equipment. All guidelines of this and of the computer manufacture must therefore be allowed at all times to ensure the safe use of the equipment.

EU Countries Intended for Use

The ETSI version of this device is intended for home and office use in Austria, Belgium, Bulgaria, Cyprus, Czech, Denmark, Estonia, Finland, France, Germany, Greece, Hungary, Ireland, Italy, Latvia, Lithuania, Luxembourg, Malta, Netherlands, Poland, Portugal, Romania, Slovakia, Slovenia, Spain, Sweden, Turkey, and United Kingdom. The ETSI version of this device is also authorized for use in EFTA member states: Iceland, Liechtenstein, Norway, and Switzerland.

EU Countries Not Intended for Use

None

EU Declaration of Conformity

- English:** This equipment is in compliance with the essential requirements and other relevant provisions of Directive 2014/53/EU, 2014/35/EU.
- Français:** Cet équipement est conforme aux exigences essentielles et autres dispositions de la directive 2014/53/EU, 2014/35/EU.
- Čeština:** Toto zařízení je v souladu se základními požadavky a ostatními příslušnými ustanoveními směrnic 2014/53/EU, 2014/35/EU.
- Polski:** Urządzenie jest zgodne z ogólnymi wymaganiami oraz szczególnymi warunkami określonymi Dyrektywą UE 2014/53/EU, 2014/35/EU.
- Română:** Acest echipament este în conformitate cu cerințele esențiale și alte prevederi relevante ale Directivei 2014/53/UE, 2014/35/UE.
- Русский:** Это оборудование соответствует основным требованиям и положениям Директивы 2014/53/EU, 2014/35/EU.
- Magyar:** Ez a berendezés megfelel az alapvető követelményeknek és más vonatkozó irányelveknek (2014/53/EU, 2014/35/EU).
- Türkçe:** Bu cihaz 2014/53/EU, 2014/35/EU direktifleri zorunlu istekler ve diğer hükümlerle ile uyumludur.
- Українська:** Обладнання відповідає вимогам і умовам директиви 2014/53/EU, 2014/35/EU.
- Slovenčina:** Toto zariadenie spĺňa základné požiadavky a ďalšie príslušné ustanovenia smerníc 2014/53/EU, 2014/35/EU.
- Deutsch:** Dieses Gerät erfüllt die Voraussetzungen gemäß den Richtlinien 2014/53/EU, 2014/35/EU.
- Español:** El presente equipo cumple los requisitos esenciales de la Directiva 2014/53/EU, 2014/35/EU.
- Italiano:** Questo apparecchio è conforme ai requisiti essenziali e alle altre disposizioni applicabili della Direttiva 2014/53/EU, 2014/35/UE.
- Nederlands:** Dit apparaat voldoet aan de essentiële eisen en andere van toepassing zijnde bepalingen van richtlijn 2014/53/EU, 2014/35/EU.
- Português:** Este equipamento cumpre os requisitos essenciais da Directiva 2014/53/EU, 2014/35/EU.
- Norsk:** Dette utstyret er i samsvar med de viktigste kravene og andre relevante regler i Direktiv 2014/53/EU, 2014/35/EU.
- Svenska:** Denna utrustning är i överensstämmelse med de väsentliga kraven och övriga relevanta bestämmelser i direktiv 2014/53/EU, 2014/35/EU.
- Dansk:** Dette udstyr er i overensstemmelse med de væsentligste krav og andre relevante forordninger i direktiv 2014/53/EU, 2014/35/EU.
- suomen kieli:** Tämä laite täyttää direktiivien 2014/53/EU, 2014/35/EU. oleelliset vaatimukset ja muut asiaankuuluvat määräykset.

FOR USE IN **AT BE CY CZ DK EE FI FR DE GR HU**
IE IT LV LT LU MT NL PL PT SK SI ES SE
GB IS LI NO CH BG RO RU TR UA



WEEE Directive & Product Disposal



At the end of its serviceable life, this product should not be treated as household or general waste. It should be handed over to the applicable collection point for the recycling of electrical and electronic equipment, or returned to the supplier for disposal.

Declaration of Conformity

We, Edimax Technology Co., Ltd., declare under our sole responsibility, that the equipment described below complies with the requirements of the European Radio Equipment directives.

Equipment: Air Box
Model No.: AI-1001W V2

The following European standards for essential requirements have been followed:

Directives 2014/53/EU

Spectrum : EN 300 328 V2.1.1 (2016-11)
EMC : EN 301 489-1 V2.2.0 (2017-03)
EN 301 489-17 V3.2.0 (2017-03)
EMF : EN 62311:2008

Directives 2014/35/EU

Safety (LVD) : IEC 60950-1:2005 (2nd Edition)+Am 1:2009+Am 2:2013
EN 60950-1:2006+A11:2009+A1:2010+A12:2011+A2:2013

Edimax Technology Europe B.V.
Fijenhof 2,
5652 AE Eindhoven,
The Netherlands

a company of :
Edimax Technology Co., Ltd.
No. 278, Xinhu 1st Rd.,
Neihu Dist., Taipei City,
Taiwan

Signature:

Printed Name: Vivian Ma
Title: Director
Edimax Technology Europe B.V.

Date of Signature: June, 2017

Signature: _____

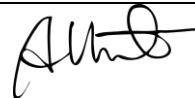

Printed Name: Albert Chang

Title: Director
Edimax Technology Co., Ltd.

